



# Why artificial reefs?

Date published: 1991

**To cite this document :** Southeast Asian Fisheries Development Center, Aquaculture Department (1991). Why artificial reefs? Aqua Farm News, 9(4), 1-8.

**Keywords :** Marine environment, Artificial reefs, Construction, Coral reefs, Habitat improvement (physical), Installation, Marine fish, Materials, Site selection, Tropical fish, INW, Japan, ISE, USA, Hawaii

**To link to this document :** <http://hdl.handle.net/10862/2622>

**Share on :** A row of small, square social media icons including Facebook, Twitter, Google+, LinkedIn, YouTube, and a document icon.

PLEASE SCROLL DOWN TO SEE THE FULL TEXT

This content was downloaded from [SEAFDEC/AQD Institutional Repository \(SAIR\)](#) - the official digital repository of scholarly and research information of the department  
Downloaded by: [Anonymous]  
On: May 26, 2019 at 11:31 AM CST



# WHY ARTIFICIAL REEFS?

Artificial reefs or man-made reefs are concrete, tire, wood or bamboo modules (or which may consist of other scrap materials) submerged in selected areas to lighten the fishing pressure on natural reefs and to concentrate fish for easier fishing.

In his paper presented at the *Regional Symposium on Coastal Waters Rehabilitation and Development* (in Iloilo City, 9 March 1989), Dr. F.J. Lacanilao, SEAFDEC/AQD Chief, noted the three recognized functions of artificial reefs: (1) as a fish-aggregating device that concentrates fish for easier fishing, (2) as protection or shelter for fish juveniles preventing their early harvest, and (3) as a means to increase coastal productivity in the long run by providing substrates for growth of sessile organisms and establishment of new food chains.

Artificial reefs have yet to be proved as a cure for the country's degraded and overfished coastal environment, and experts have cautioned on the possibility of their misuse. Thus, investigations on the biological and ecological functions of artificial reefs are continuing. Some findings and recommendations are reported below.

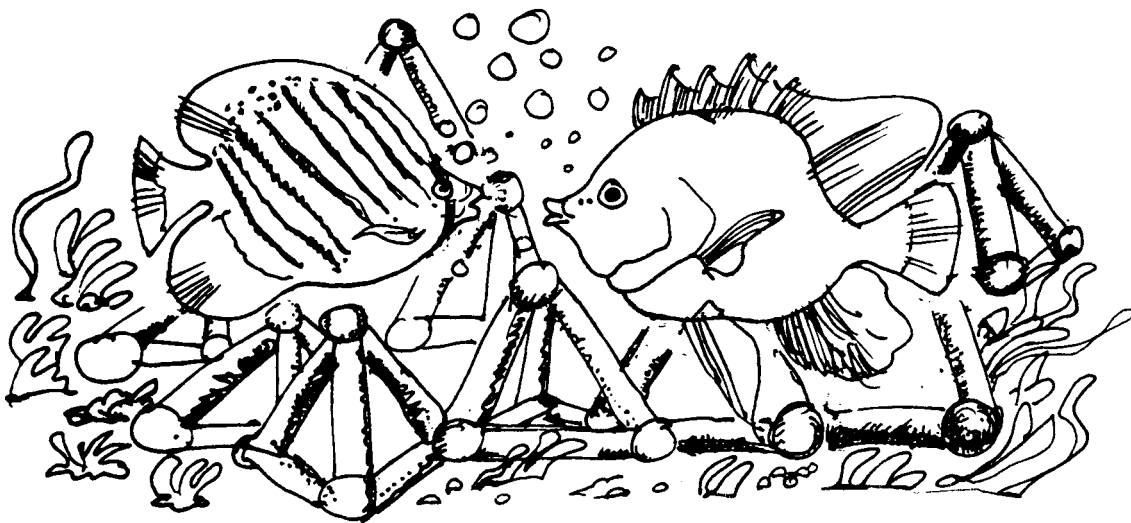

*Is this your new dig? Coziest condo in town!  
Wait till our friends hear this!*

*Yeah! Part of the Urban Renewal Program!*

## Item One: Flow Chart for the Installation of an Artificial Reef

Details of planning, site selection, data collection, and analysis in the flowchart (see p. 2) are as follows:

### (1) *Underwater Topography and Geography*

The site should be selected depending on the features of the underwater topography, which are shown by the contour lines as in the figure on p. 3. More specifically, the suitability of each site should depend on the seabed gradient, i.e., an artificial reef can be installed where the seabed flattens out. This information may be obtained from local fishermen, or through a natural reef survey.

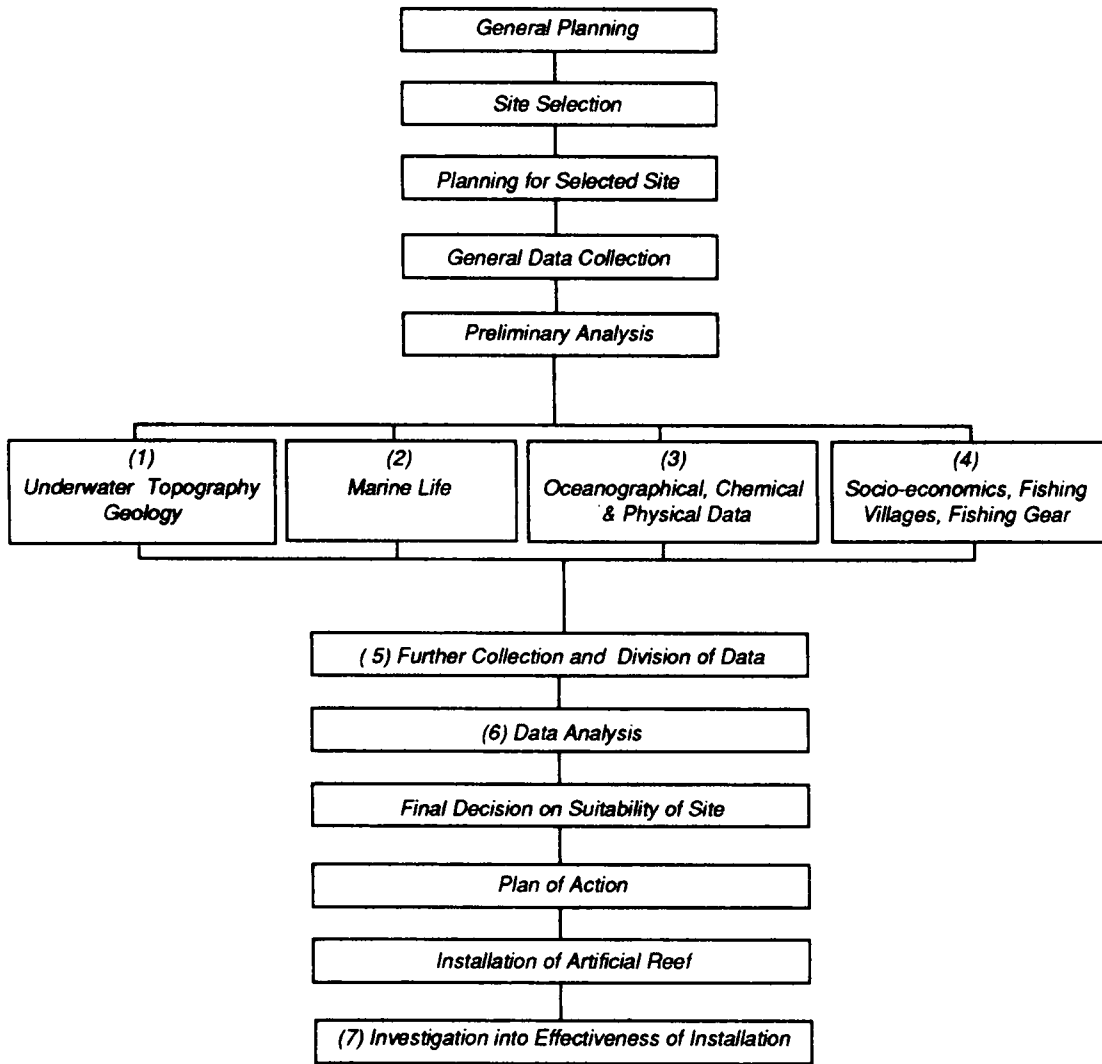

Planning, site selection, data collection, and analysis.

**(2) Marine Life**

The target species should be chosen from those species which are commercially more highly priced. The target species should be observed throughout the various phases of development. Their feeding habits and predator-prey interaction should be observed and their ecological characteristics should also be studied. The possible size of catch should also be evaluated.

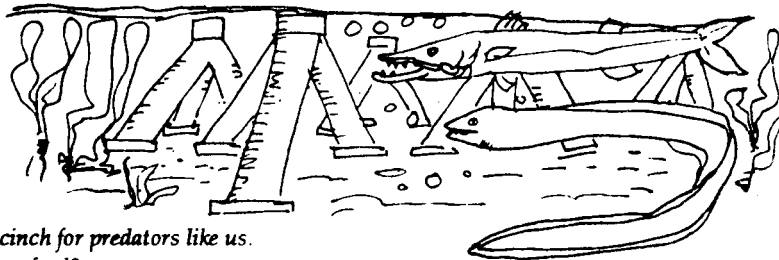

*I thought it would be a cinch for predators like us.  
How come I don't see any food?*

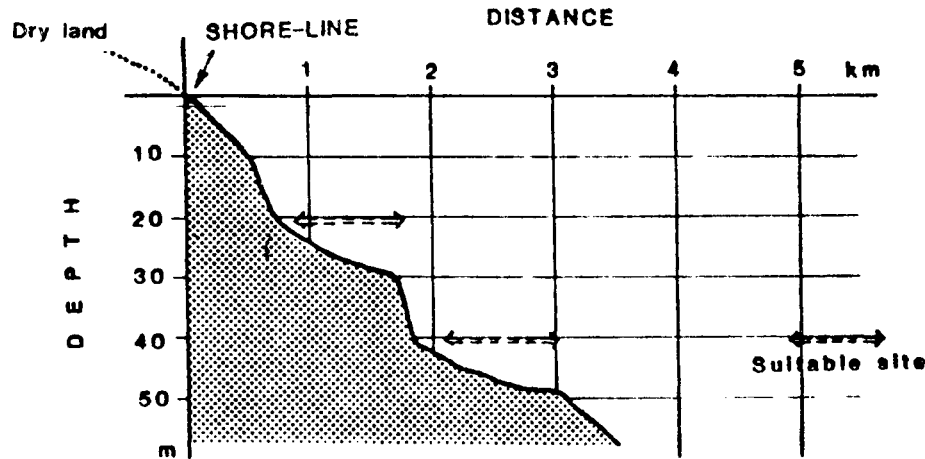

A suitable site is where the seabed flattens out.

(3) Oceanography

Oceanographical data, especially relating to currents and waves, should be collected for two reasons, namely, to calculate the external pressure exerted on modules and to assess the environmental conditions at the site.

Current velocity and direction should be measured throughout the year, and the period of each measurement should last for at least fifteen days, which should be the fixed period for an oceanographical measurement. Data on waves, on the other hand, should be collected over a longer period, and this can also be predicted from data gathered on wind. Temperature and salinity levels should be measured at the same time as the current measurements are being made. With regard to the chemical data required, nutrient salts (e.g., phosphate-P, ammonium-N, nitrate-N, and nitrite-N) in seawater and the chlorophyll-a contents of suspended particles should also be analyzed. In addition, nutrient salts are an important chemical factor for maintaining primary production at the site. The contents of chlorophyll-a are also an indicator of phytoplankton biomass and of potential primary production.

(4) Socioeconomics

In order to clarify the situation at the site, data should be collected on the following:

- the number of fishermen using the site
- the cost of the fishing operation
- the kinds of fishing gear used
- the quantity and value of the fish which is processed
- the different types of fishing gear used at the fishing ground
- the number of fishing villages near the site and of fishing cooperatives
- illegal fishing that is carried out.

To ensure the success of each operation, fishing ground management should be considered at the planning stage.

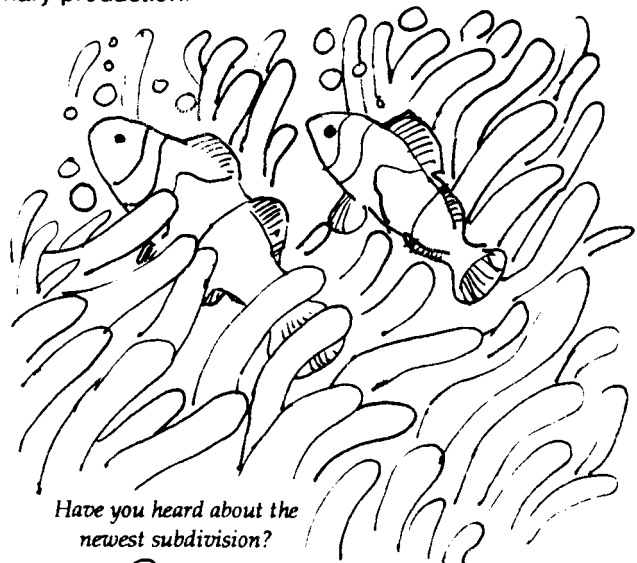

Have you heard about the newest subdivision?

Yeah, but nothing beats our natural habitat. I'm not moving.

(5) *Further collection and division of data*

If any of the above-mentioned data proves impossible to collect or is insufficient, further survey should be carried out. Fishermen using the site should be interviewed and the information collated so as to understand better the effectiveness and validity of the methodology.

(6) *Data analysis*

All the data collected relating to items (1) to (5) should be analyzed section by section as bases for deciding whether to proceed with the project or not. The level of investment required can be projected based on the data collected.

(7) *Follow-up*

At least one year after the installation of the artificial reef, the surveys should be repeated for items (1) to (4). Then a re-evaluation should be made to see whether the operation can be improved; if so, where and how.

From the planning stage onwards, the local fishermen should be consulted since their experience and knowledge of the proposed site are a valuable contribution to the development of the project. Most fishermen in the surrounding area are aware of the topography and marine life at the proposed site. In addition, the effectiveness of the project should be cross-checked with similar sites in the region.

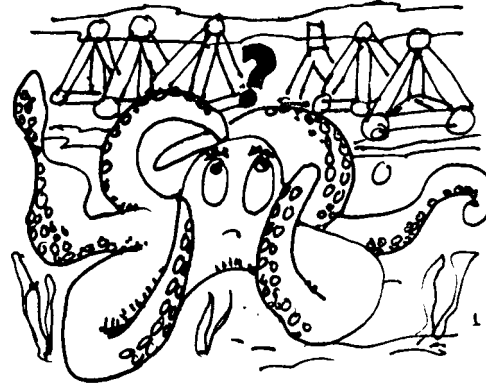

*I'm lost! This must be a new neighborhood.*

## Item Two: Site Selection

Site selection criteria for the installation of an artificial reef are as follows:

(1) There should be a satisfactory concentration of fish at the site, and the fishermen living near the site should be able to use the reef effectively.

(2) From the point of view of the marine life, the area should be a suitable breeding ground and habitat for the target species and, furthermore, the area should be on the route along which the species migrate.

Fish change their environment according to the various stages of their development. For instance, at the fry stage, especially immediately after hatching, they float on the surface of the sea. At the juvenile stage, when their mouths remain open and until they start feeding, they are mostly concentrated along shallow, coastal nursery areas which are sometimes areas of marine forest. From the beginning of the juvenile stage until they become adults, fish continue to migrate until they return to their original starting point. This migration is controlled by the environment, the most important factors being temperature, salinity, and depth.

Based on the relationship between the environment and stages of development, the target species may be chosen and their life history analyzed.

(3) From an environmental point of view, the physical and chemical conditions around the site have to be suitable.

The physical conditions that should be considered are temperature, salinity, current direction, current velocity, underwater topography, and the type and quality of the seabed.

Current direction and velocity should be worked out by mapping counter-currents, eddies, and upwellings. The type and quality of the seabed depend on the current velocity. If a current exists, the seabed will consist of sand and/or gravel. The underwater topography needs to be

worked out by mapping variations in the seabed such as banks, caldrons and depressions. Where there are extensive sandy areas, the flat area between a steep slope and the continental shelf should be selected.

To select a suitable site, data of all kinds should be collected and a site chosen after close analysis. Data gathering is very time-consuming and requires considerable financial investment. Interviews with local fishermen will be beneficial and will save time and money.

Source of Items One and Two: Wajiro Fujisawa, **Technical Manual for Resource Enhancement**. February 1990. Training Department, Southeast Asian Fisheries Development Center, Bangkok, Thailand.

### Item Three: Characteristics of Coral and Artificial Reefs

Coral reefs	Artificial reefs
Natural living structures depend on specific environmental factors such as light, salinity, temperature, and suitable substrate for basic framework development.	Artificial structures are independent of environmental conditions for basic framework development.
Shape, size, location, and orientation depend on environment and age.	Shape, size, location, and orientation do not depend on environment and age.
Basic framework of calcium carbonate. Development is slow as coral growth is 15-20 cm/yr at best. No cost involved.	Basic framework of metal, concrete, tires, wood, etc. Rate of framework development could be fast but cost-related except as natural growth occurs.
Longevity of basic framework is indefinite.	Longevity depends on materials.
Recruitment of marine life is dependent on environmental conditions, shape, size, and biological health of the coral reef.	Recruitment of marine life is dependent on environmental conditions and the nature of framework.
High primary production from algae, corals, etc.	Primary production is dependent on area available for photosynthetic marine organisms to grow on basic framework.
Recesses and crevices naturally present in the framework provide shelter and hiding spaces for a large variety of marine organisms.	Hiding space provision is limited by the basic framework. The size and species which will attach depend largely on the size and the nature of hiding spaces provided which depend on cost.
Establishment of new coral reefs through transplantation and other techniques is slow, time-consuming, and of limited application.	Establishment of artificial reefs is relatively fast and has proven to be cost-effective in specific instances.
Fish production figures of 9.7-32 t/km <sup>2</sup> /yr of coral have been recorded.	Very little actual detailed work carried out on fish yield, etc. However, definite enhancement in fish aggregation has been recorded. In the Philippines, 312 m <sup>2</sup> of bottom area of artificial reef has produced yields of 2 kg/week.

### Item Four: The Hawaiian Experience

Average number of species and standing crop of fish at various artificial reef sites in Hawaii prior and subsequent to the deployment of artificial reef materials are shown below:

	Prereef inventories		Postreef inventories	
	No. of species	Standing crop (kg/ha)	No. of species	Standing crop (kg/ha)
Maunalua Bay, Oahu	20	7	43	154
Waianae, Oahu	32	19	41	137
Kualoa, Oahu	24	17	No subsequent surveys	
Kaewakapu, Maui	6	0.6	25	41

Source of Items Three and Four: Alan T. White, Chou Loke Ming, M.W.R.N. de Silva, Flordeliz Y. Guarin, *Artificial Reefs for Marine Habitat Enhancement in Southeast Asia*. 1990. ICLARM. MC. P.O. Box 1501, Makati, Metro Manila.

### Item Five: Concrete - Best Material for Artificial Reefs

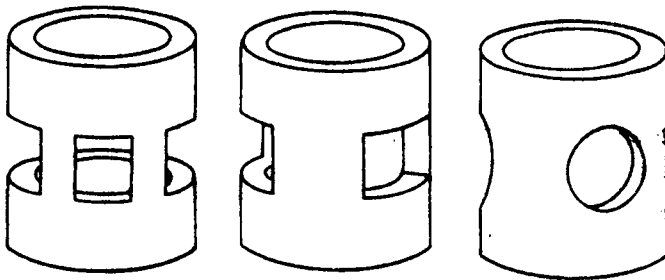
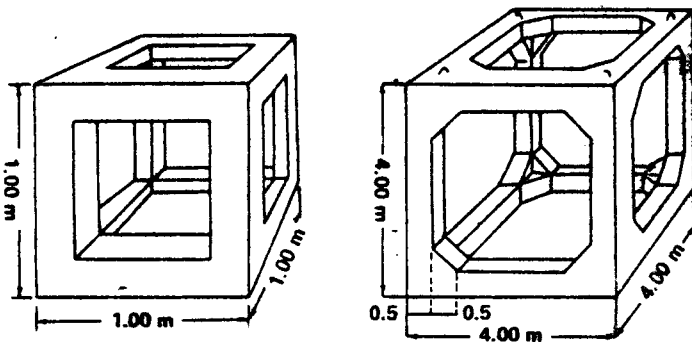

Concrete dice (1st row) and tube (2nd row) blocks  
(SEAFDEC Newsletter, Vol. 10, No. 3. 1987).

To find out what surfaces best attract and maintain the presence and growth of corals, University of Hawaii zoology professor Dr. Julie Bailey-Brock and her assistant, doctoral candidate Rachel Fitzhardinge, have been measuring the recruitment of corals on materials commonly used to construct artificial reefs. Recruitment refers to the number of organisms that initially settle minus the number that die before a count is made.

Four materials were tested at various locations in Kaneohe Bay, in the Sea Grant-funded project. The materials - rubber tires, metal (a car hood), concrete, and dead coral - were fashioned into sets of flat plates, about 38.7 cm<sup>2</sup>. These plates were then placed in the bay at a depth of about 4.6 m. Sets of plates were removed after 2 weeks to 1 year and coral settlement and survival were estimated

for the different test materials.

After several months in the bay, the metal plates had the highest recruitment of corals, dead coral and concrete followed, while the rubber tire plates had the lowest. According to Bailey-Brock, this may possibly be due to chemicals leached from the rubber tires. Four species were recruited to the plates, including three species of hermatypic (reef-building) corals.

Although the metal plates had the highest rate of recruitment, recruitment of organisms on the concrete more closely resembled that on natural surfaces (like dead coral). This, and the fact that thin sheet-metal structures, such as car bodies tend to deteriorate rapidly in seawater, led researchers to conclude that **concrete was the best material for constructing artificial reefs.**

Source: Daniel Bauer, "Artificial Reef Materials Make a Difference to Corals," *Makai, University of Hawaii Sea Grant College Program*, Vol. 9, No. 2, February 1987.

#### Item Six: The Japanese Experience

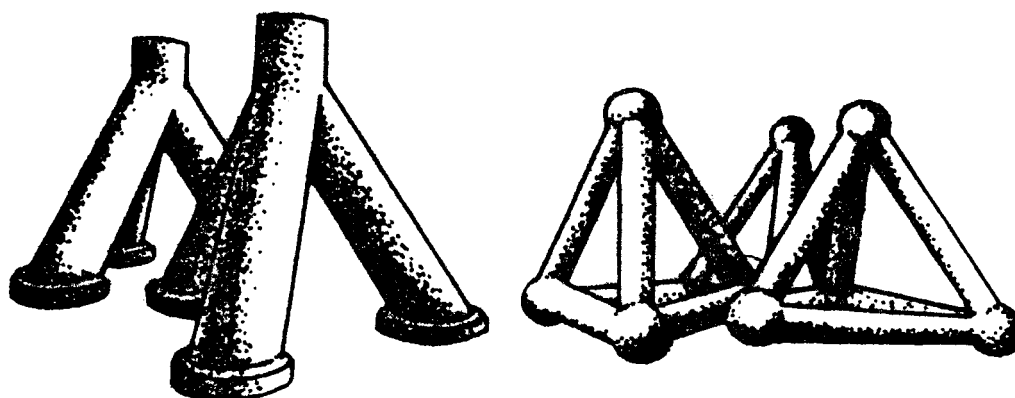

Triangular and ball-joint modules (*SEAFDEC Newsletter*, Vol. 12, No. 4, 1989).

As early as 1952, the Japanese Government began a subsidy program to support the construction of artificial reefs. At first, drawing on historical experience, small-scale artificial reefs were sunk in local waters. Now, large-scale devices, comparable in size to natural reefs, are being installed offshore. Artificial reefs from small to extra large scale (400 m<sup>3</sup> bulk volume to 150,000 m<sup>3</sup> and over) are being subsidized by both national and local governments.

The first industrial fishing reefs were constructed in Japan in 1954. These consisted of concrete blocks. By 1977, other materials, such as steel, were being used.

Mr. Wajiro Fujisawa, a Japanese expert on artificial reefs, cautioned that the construction of artificial reefs on sea bottom requires serious study since all areas are not necessarily suited for them. Some of the factors to be considered include:

- biological data on more than one of the major fish species in the area;
- data on the life history of these species;
- oceanographic surveys of the topography and geology of the sea bottom;
- an analysis of the water, covering particularly temperature, salinity, DO, pH, current direction and speed, wave patterns, etc.;
- information on the fishing gear used; and
- economic estimates of the income expected to be derived by fishermen from the fishing reefs.

These data will help establish suitable construction sites and determine the scale of the



reefs needed. Just as important, once the reef has been constructed, is the follow-up phase to evaluate the economic benefits accrued and, eventually, improve the engineering and standardize the technology.

According to Mr. Fujisawa, even in Japan, some unresolved questions remain, one of which concerns the effect of artificial reefs on catch increases. The Japanese experience has not yet established whether the devices actually increase production rather than aggregate fishes. So far, there is no concrete data addressing this question.

On the other hand, part of the popularity of artificial reefs in Japan stems from the fact that they favor small vessels using traditional gear while large trawl nets run the risk of being damaged by them. As a result, the construction of artificial reefs has boosted employment and increased productivity for small fishing communities and fishermen's cooperatives along the country's coastal waters.

Source: SEAFDEC Newsletter, Vol. 10, No. 3, 1987, Bangkok, Thailand.

### **A Footnote to the Artificial Reef Issue**

Scientists led by Alan T. White (White A.T., C.L. Ming, M.W.R.N. de Silva, F.Y. Guarin. 1990. *Artificial Reefs for Marine Habitat Enhancement in Southeast Asia*. ICLARM. MC. P.O. Box 1501, Makati, Metro Manila) suggested that although "the use of scrap materials in generating artificial reefs may be an economic way to solve solid waste disposal problems on land ... It may damage marine habitats. Scrap materials can release toxic pollutants to marine food chains. Some may even add to the already increasing debris in coastal waters. Research on the viability of artificial reefs should be improved before moving into large-scale programs. In 1969, a scientist warned that if we don't base 'a reef's construction upon proper scientific principles, it becomes at best a temporary high relief area of questionable value, or at worst an ocean junk pile whose major value has been as a promotional gimmick publicizing a special interest group.' "

Other scientists also said that "perhaps too much effort has been expended in building artificial reefs and not enough in research . . . not all artificial reefs have increased fish harvest or productivity. In many areas, managers have the mistaken belief that they can proceed with large-scale programs without research. Decisions are often made based on political expediency, absolute cost, readily available materials, navigational considerations or solid waste disposal problems, without considering biological, economic, or social effects. The potential exists for major mistakes which could be difficult, costly, or impossible to correct."

Many artificial reef programs have failed because waste materials have been dumped in the cheapest way possible and haphazardly. The environmental and other costs have shown that this shortsighted approach is undesirable. The best alternative in terms of environmental, economic and social benefits is a carefully planned, well-managed structure.

