

# Management of Milkfish Broodstock

A.C. Emata, C.L. Marte, L.Ma.B. Garcia



AQUACULTURE DEPARTMENT  
SOUTHEAST ASIAN FISHERIES DEVELOPMENT CENTER  
Iloilo, Iloilo, Philippines



AQUACULTURE EXTENSION MANUAL NO. 20  
DECEMBER 1992

# *Management of Milkfish Broodstock*

A.C. Emata  
C.L. Marte  
L.Ma.B. Garcia



AQUACULTURE DEPARTMENT  
SOUTHEAST ASIAN FISHERIES DEVELOPMENT CENTER  
Tigbauan, Iloilo, Philippines

MANAGEMENT OF MILKFISH BROODSTOCK  
Aquaculture Extension Manual No. 20

ISBN 971-8511-24-5

*Published and Printed by*  
Aquaculture Department  
Southeast Asian Fisheries Development Center (SEAFDEC)  
Tigbauan, Iloilo, Philippines

Copyright © 1992  
Aquaculture Department  
Southeast Asian Fisheries Development Center (SEAFDEC)  
Tigbauan, Iloilo, Philippines

All Rights Reserved

No part of this publication may be reproduced or transmitted in any form or by any means, electronic or mechanical, including photocopy, recording, or any information storage and retrieval system, without the permission in writing from the publisher.

## *Preface*

In 1984, a guide for the establishment and maintenance of milkfish broodstock was published following the spontaneous maturation and spawning of milkfish broodstock in floating cages. That manual was primarily for government researchers and technicians involved with the National Bangus Breeding Program.

Since then, research on seed production at SEAFDEC/AQD has led to several significant developments, including (1) improved egg collection techniques, (2) a standard egg transport procedure, (3) the spontaneous maturation and spawning of milkfish in concrete tanks, and (4) an improved hatchery technology. Revision of the manual on milkfish broodstock management was therefore necessary to include these developments.

The production of the maximum number of good quality eggs and larvae from available spawners remains the primary objective of any finfish broodstock management. Coupled with better hatchery techniques for optimum fry survival, captive broodstock will ensure increased seed production. For milkfish, in particular, this will provide an alternative answer to the enormous fry demand.

A.C. Emata  
C.L. Marte  
L.Ma. B. Garcia

December 1992



*MANAGEMENT OF MILKFISH BROODSTOCK*  
Aquaculture Extension Manual No. 20  
December 1992

***Contents***

*Preface*, **iii**

Introduction, **1**

Reproductive biology, **2**

Sources of broodstock, **4**

Holding facilities for broodstock, **4**

Feeding, **9**

Determination of gonadal development, **9**

Spawning and egg collection, **12**

Transport of spawned eggs, **17**

Determination of percent viable eggs, **18**

Determination of hatching rate, **19**

Postscript, **21**

Acknowledgment, **21**

References, **22**





## *Introduction*

Milkfish, *Chanos chanos* (Forsskal), is an important food fish traditionally cultured in Southeast Asian countries, particularly the Philippines, Taiwan, and Indonesia. It is hardy, fast-growing, and euryhaline. In the Philippines, about 211,000 ha of brackishwater ponds and 5,000 ha of freshwater fishpens are used for milkfish production (Fig. 1; Fishery Statistics Bulletin, 1991). In 1990, the Philippines produced 210,882 mt of milkfish - 191,878 mt from brackishwater and 19,004 mt from freshwater - valued at US\$277,000. However, the fry needed to stock culture ponds and pens still come exclusively from coastal waters (Fig. 2). The 3-wk old fry are collected in large numbers during the breeding season. However, the annual recruitment of wild fry is unstable and is threatened by coastal pollution. The demand for milkfish fry has spurred studies on broodstock development, artificial propagation, and mass fry production in hatcheries to supplement the natural supply and eventually break the dependence on wild sources.

The difficulty in obtaining sexually gravid milkfish from the wild and the limited success in induced maturation and spawning prompted the development and establishment of milkfish broodstock. Significant



Fig. 1. Milkfish harvest in ponds or pens.



Fig. 2. Milkfish fry collection in coastal waters during the spawning season.

achievements in the development of milkfish broodstock began in 1980 with the spontaneous maturation of 5-yr old milkfish held in floating net cages (Lacanilao and Marte, 1980). Since then, milkfish has consistently spawned naturally in floating net cages (Marte and Lacanilao, 1986). Recently, 8- and 9-yr old milkfish have spontaneously matured and spawned in concrete tanks (Emata and Marte, 1990; 1991). Natural spawnings of milkfish in both holding structures, together with mass fry production using hatchery technology developed by SEAFDEC/AQD (Gapasin and Marte, 1990), could definitely supplement and ultimately break the dependence on the natural supply of milkfish fry.

### *Reproductive biology*

Captive milkfish mature and spawn at 5 years of age. Tank- or cage-reared adult milkfish weigh around 2.5-9.0 kg. Among captive females, the ratio of gonad weight relative to body weight (gonadosomatic index, GSI) ranges from 0.05% (immature) to 4.46% (mature) (Marte, 1989; Fig. 3). In contrast, mature ovary can take as much as 25% of body weight of wild-caught milkfish (Bagarinao, 1991). Captive females produce an average of 200,000 eggs/kg (Marte and Lacanilao, 1986). Im-

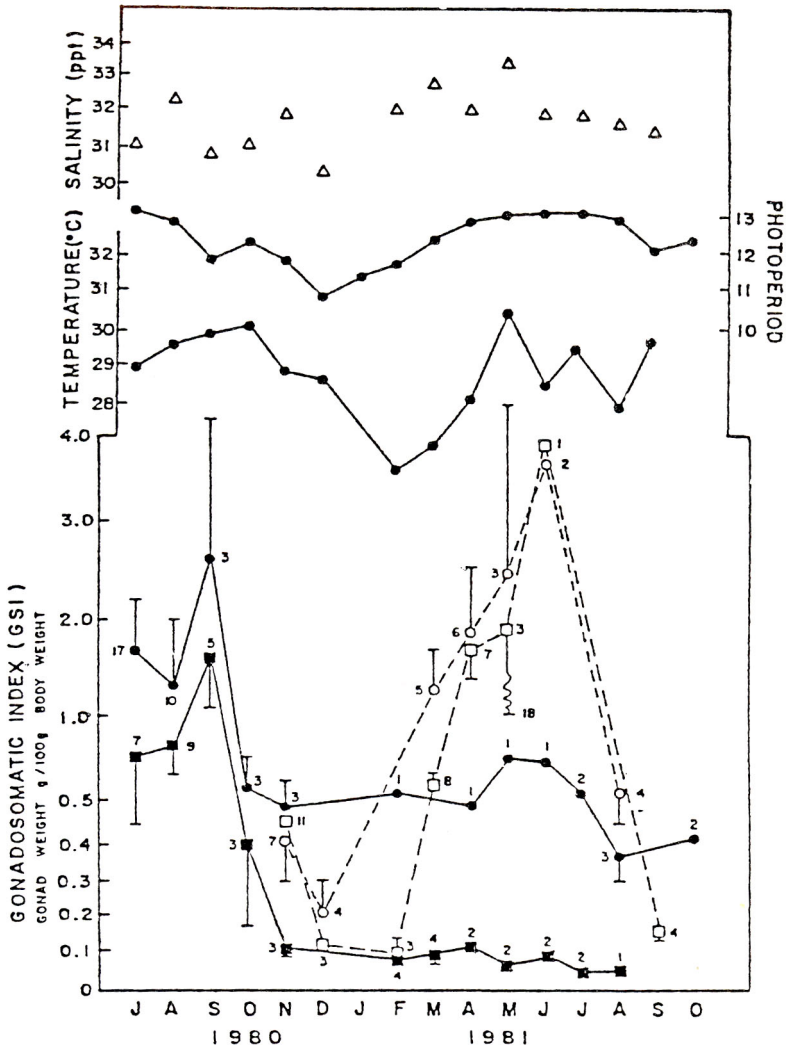

Fig. 3. Mean monthly gonadosomatic index of milkfish broodstock from wild-caught fry reared in two cages (cage 1: female, ●●; male, ■■; and cage 2: female, ○○; male, □□) (Marte & Lacanilao 1986).

mature captive males have a GSI of 0.1% that increases to 4.0% as maturity is attained (Fig. 3).

In captivity, milkfish broodstock are immature in December and January, gonadal development begins in February and March, and spawning occurs from April to November. This pattern is consistent with the occurrence of milkfish adults, eggs, and fry in coastal areas (Bagarinao, 1991). The spawning season appears to coincide with a long photoperiod and relatively high temperatures (Marte and Lacanilao, 1986).

## *Sources of broodstock*

Milkfish juveniles (weight, 250-350 g) can be obtained from brackishwater ponds and fish pens where they have been cultured for a few months to a year.

Milkfish juveniles are transported to the broodstock cages or tanks in a floating fish cage (Fig. 4) or in a 1.5-m dia. canvas tank with 0.5-m deep water with aeration. The canvas tank may be suspended at the back of a pick-up truck or placed in the hull of a pumpboat.

For a start, about 100 juveniles can be stocked in 10-m dia. cage or tank. After three years, half of this stock can be transferred to another 10-m dia. cage or tank until maturity is attained. At this time, another 100 juveniles can be stocked in another 10-m dia. cage or tank.

## *Holding facilities for broodstock*

Floating cages must be located in a well protected area with minimum wave action even under adverse weather conditions. The site should have good water circulation, sandy-muddy substrate, and a minimum water depth of 5 m at the lowest tide.

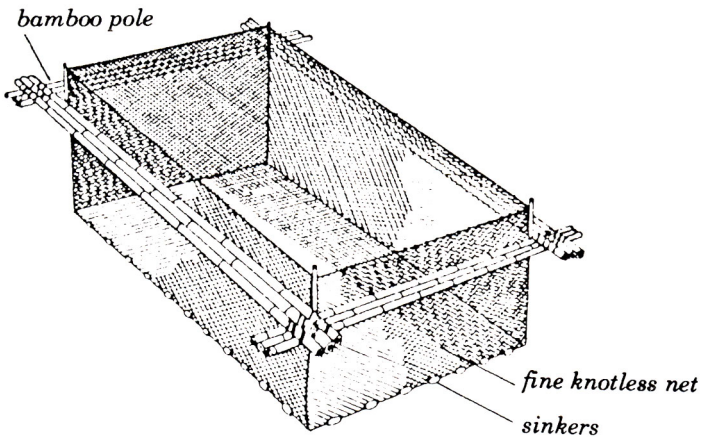

Fig. 4. Floating net cage (3 m x 1.5 m x 1 m-deep) for transport of juvenile milkfish to broodstock sites (Marte *et al.*, 1984).

Milkfish are then reared in 6- or 10-m dia. x 3-m deep floating net cages (Figs. 5-6). Coralon net (mesh size, 5.7 cm; size of twine, 210d/60) previously treated with coal tar is used as cage netting. A net allowance of about 30% is provided to have good water exchange. The top is covered with a similar net size to prevent fish from jumping out. The bottom is covered with fine knotless net (mesh size, 3 mm) to retain sinking food. The cages are supported by floats either cylindrical styrofoam or empty plastic drums (0.6-m dia. x 1 m) fitted to the cage frame, but allowing for easy rotation to check fouling. Canvas cloth or fine net (mesh size, 1 mm) is wrapped around the floats for protection against fouling organisms.

Cage maintenance is done regularly and involves:

1. Daily inspection to detect tears in the netting and to remove debris and fouling organisms;
2. Periodic rotation of cylindrical floats, repainting of wooden frame or galvanized iron (GI) pipe with coal tar; and
3. Changing of nets every 2 months or as needed to protect it from fouling organisms.

Fouled nets are sun-dried, cleaned, and repaired. When the spawning season starts, nets are left alone so that fish are not disturbed. Stress results in gonadal regression and delay of spawning.

Land-based concrete tanks measuring 8 m x 8 m x 2-m deep are sufficient for milkfish broodstock (Fig. 7). A double pipe drainage is installed to allow water to flow out from the bottom. Water inlets and aeration lines are located at the top. A black sack cloth covers the tank to minimize excessive growth of algae.

Daily water inflow should be adjusted to change at least 50% of the water volume. The sides and bottom of the tank should be brushed monthly. The tank can be drained to at least a foot in depth for brushing. During the spawning season, water inflow should be increased so that brushing and draining can be minimized.

In both tanks and cages, optimum stocking density should not be more than 1 kg/m<sup>3</sup>.



Fig. 5. Floating net cages at SEAFDEC/AQD's Igang Marine Substation.

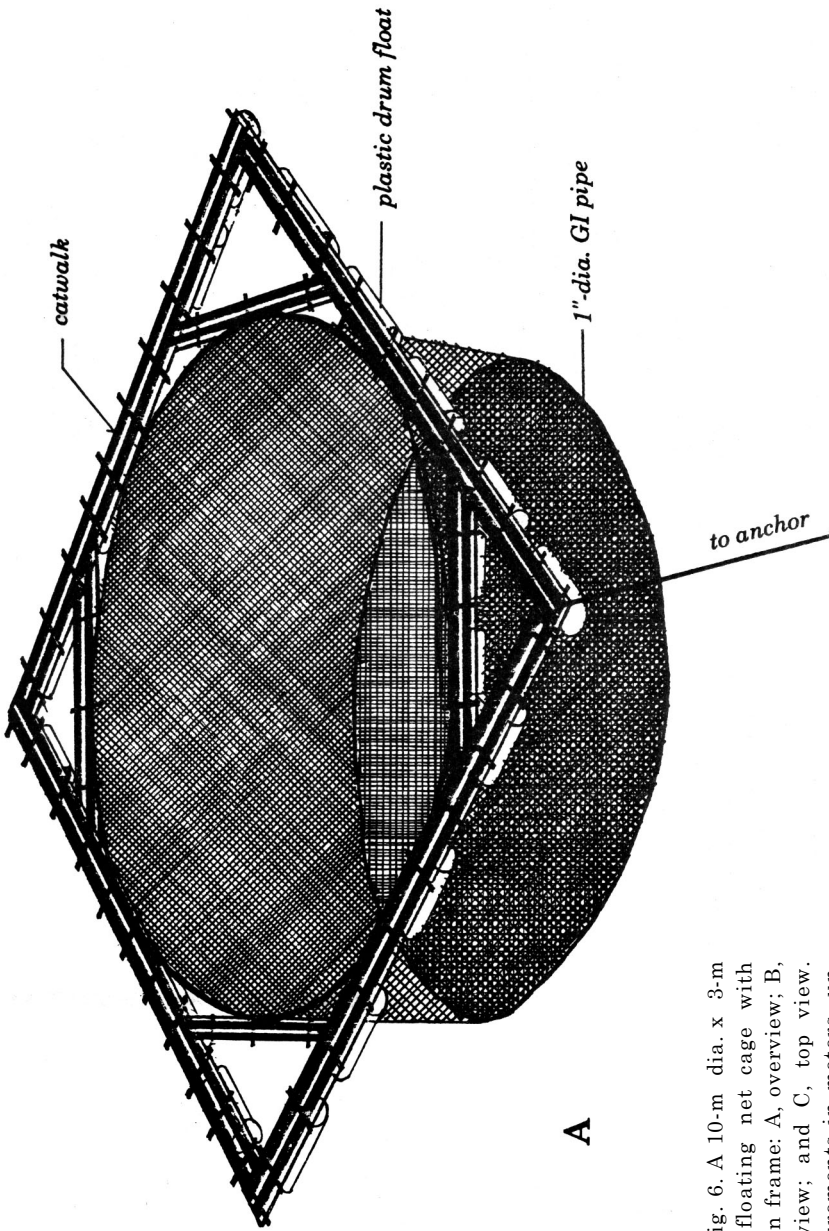

Fig. 6. A 10-m dia. x 3-m deep floating net cage with wooden frame: A, overview; B, side view; and C, top view. Measurements in meters, unless specified otherwise.

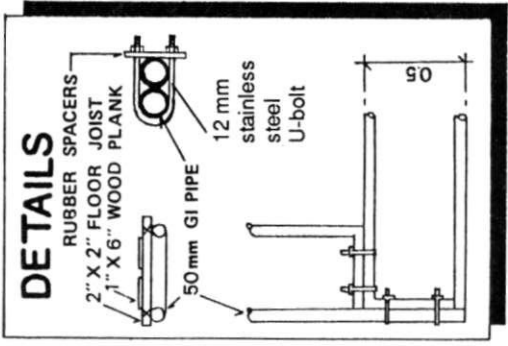
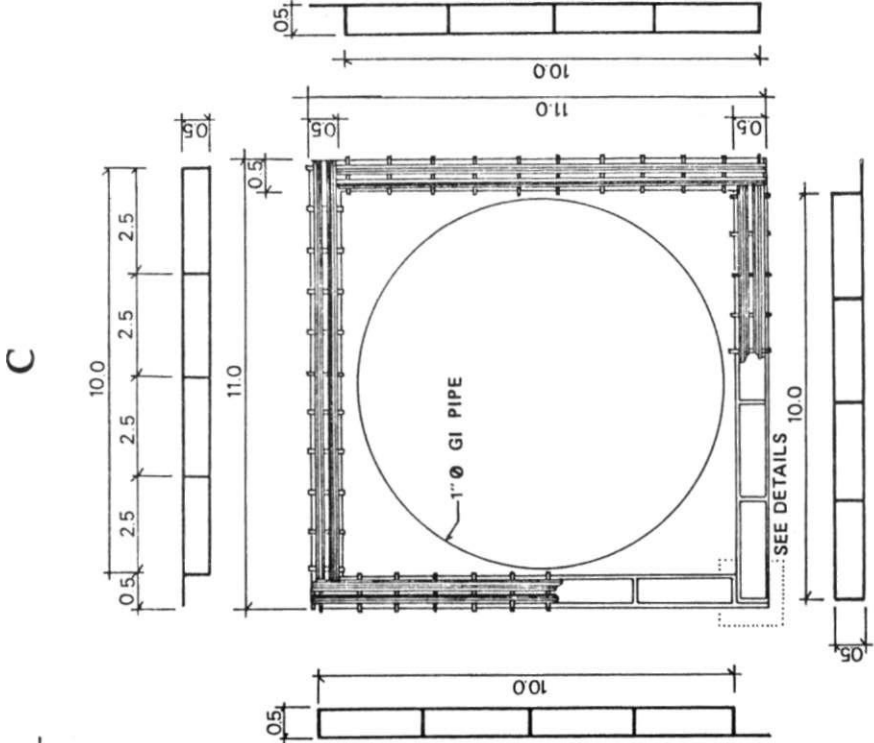
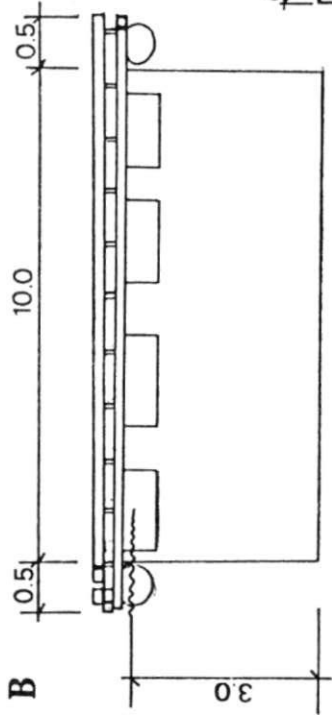





Fig. 7. Concrete tanks for milkfish broodstock at SEAFDEC/AQD's Tigbauan Main Station.

## *Feeding*

Two- to 4-yr old milkfish are fed twice daily with commercial fish pellets (24% protein) at 3% of their total body weight. Upon nearing maturation by the fourth year, fish are fed twice daily with commercial shrimp pellets with 36-42% protein and 6-8% lipid. Daily feeding ration is increased to 4% of total body weight. Feeds are broadcast to the fish by hand.

## *Determination of gonadal development*

From the fifth year and thereafter, the fish are sampled in March and in November to determine the stage of gonadal development and to determine the sexual composition of the stock. A sex ratio of one female to one male or two females to one male is adequate for egg production. Unsexed fish can be kept in a separate cage or tank to be sexed later in the season or in the next season. Excess males can be sacrificed, or released to the sea in order to save on feeds.



Fig. 8. Fish are seined from drained tanks.

The stage of gonadal development can be monitored through the cannulation biopsy technique. The nets of the floating cages are lifted gradually, or the concrete tanks drained (Fig. 8). Disturbance must be minimized to prevent any physical injury to fish.

Fish are individually scooped out and then placed in a 400-l fiberglass tank containing 200 l seawater and 200 ppm (40 ml) 2-phenoxyethanol (an anesthetic). The anesthetic should be mixed with a little water before it is placed in the tank. Anesthetized fish are characterized by loss of balance (ventral side up), immobility, and rapid and shallow opercular movement (Fig. 9).

Fish are weighed (Fig. 10) and then transferred to a shallow trough (0.5 m x 1.5 m x 0.15-m deep) containing 100 ppm 2-phenoxyethanol to keep the fish anesthetized.

Cannulation biopsy is done in the following manner:

In the wooden trough, the fish is laid on its dorsal side. To determine the presence of white viscous milt, its ventral side is gently pressed, starting from halfway of the abdomen to the anal region.

If no milt oozes out, a cannula (polyethylene tubing, PE 100; inner dia., 0.86 mm; outer dia., 1.52 mm; Clay Adams, New Jersey, USA) is inserted into the genital pore, the second opening in the urogenital area relative to the head (Fig. 11). Difficulty in inserting the cannula through the genital pore may be encountered among broodstock undergoing their first maturation and among fish examined early in the



Fig. 9. Anesthetized fish exhibits loss of balance and rapid but shallow opercular movement.



Fig. 10. Weighing milkfish.

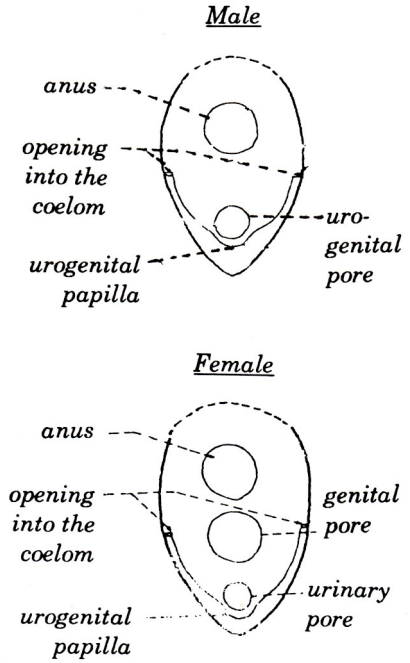

Fig. 11. Anal region of milkfish (Chaudhuri *et al.*, 1977).

breeding season. The free end of the cannula is held in the mouth (Fig. 12). The cannula is aspirated while slowly being withdrawn from the fish.

The cannula is immediately inspected. A milky whitish substance indicates a maturing or mature male. Spherical yolky oocytes appear translucent to opaque (quite distinct from fatty tissue which lines the abdominal wall). Cannulated gonadal tissue are then blown into a small covered tube (e.g., microcentrifuge tube) and 5% formalin solution is added to preserve oocytes for examination and measurement (Fig. 13).

A few oocytes are pipetted from the microcentrifuge tubes and placed on a glass slide. The diameter of 10-30 oocytes are measured under a microscope provided with an ocular ruler. Oocyte size indicates degree of sexual maturity. Females with an oocyte diameter equal to or greater than 0.67 mm are considered near final maturation and spawning. As revealed by induced spawning studies (Juario et. al. 1984; Marte et al. 1988), those with oocyte diameter less than 0.67 mm are maturing or early matured.

Following sampling, the fish are placed in a recovery tank with flow-through water and aeration. Fish must be fully recovered and swimming normally before they are returned to the main tank. Recovery from anesthesia in fresh seawater can be facilitated by holding the fish in the caudal peduncle and swinging it back and forth until opercular movement becomes normal and equilibrium is regained.

## *Spawning and egg collection*

Mature milkfish are left to spawn naturally in cages or tanks.

When spawning is expected, the cage is prepared for the collection of spawned eggs. A manually-operated egg collector is installed over the floating cage (Fig. 14). The egg collector is constructed of two parallel GI pipes (0.75-in. dia.) connected to a central shaft supported by a wooden truss frame. A fine net (mesh size, 0.6-0.8 mm) is attached to the parallel pipes with a detachable conical net bag on the far end. A bamboo pole attached to the central shaft serves as a handle for manual rotation of the egg collector around the cage.

To retain spawned eggs, a 5.8- or 9.8-m dia. circular *hapa* net made of nylon netting (mesh size, 1 mm) is installed inside the 6- or 10-m dia. floating net cage, respectively (Fig. 14A). A half sack of sand or gravel is dropped to the bottom of the *hapa* net lining to maintain its cylindrical shape. The *hapa* net is set in place at night. It is taken out of the water at daytime on alternate days to extend its life span and to



Fig. 12. Cannulation biopsy of milkfish to determine presence of eggs.



Fig. 13. Cannulated gonadal tissue are blown into a microcentrifuge tube and fixed in 5% formalin solution for later examination.

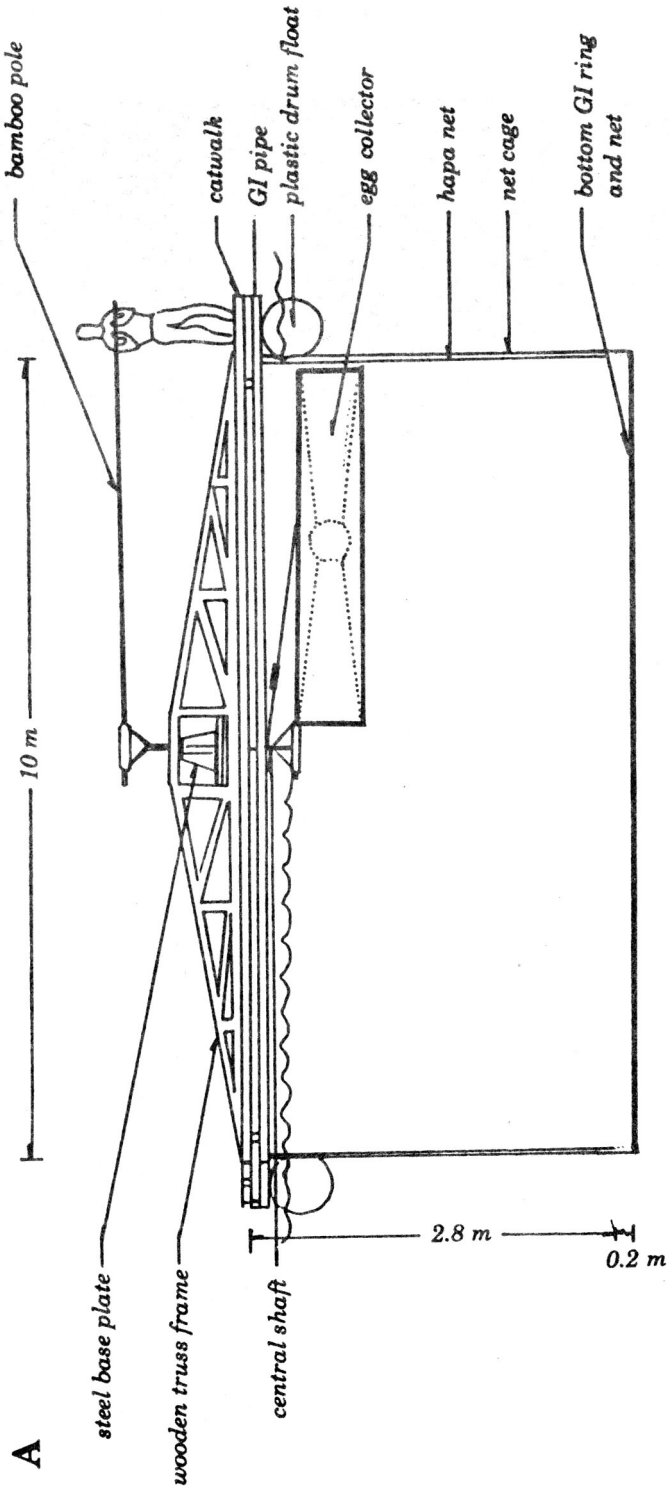
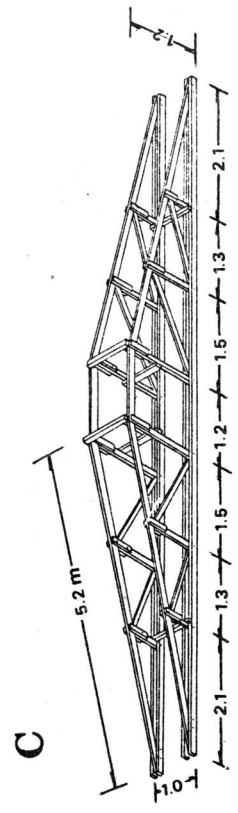
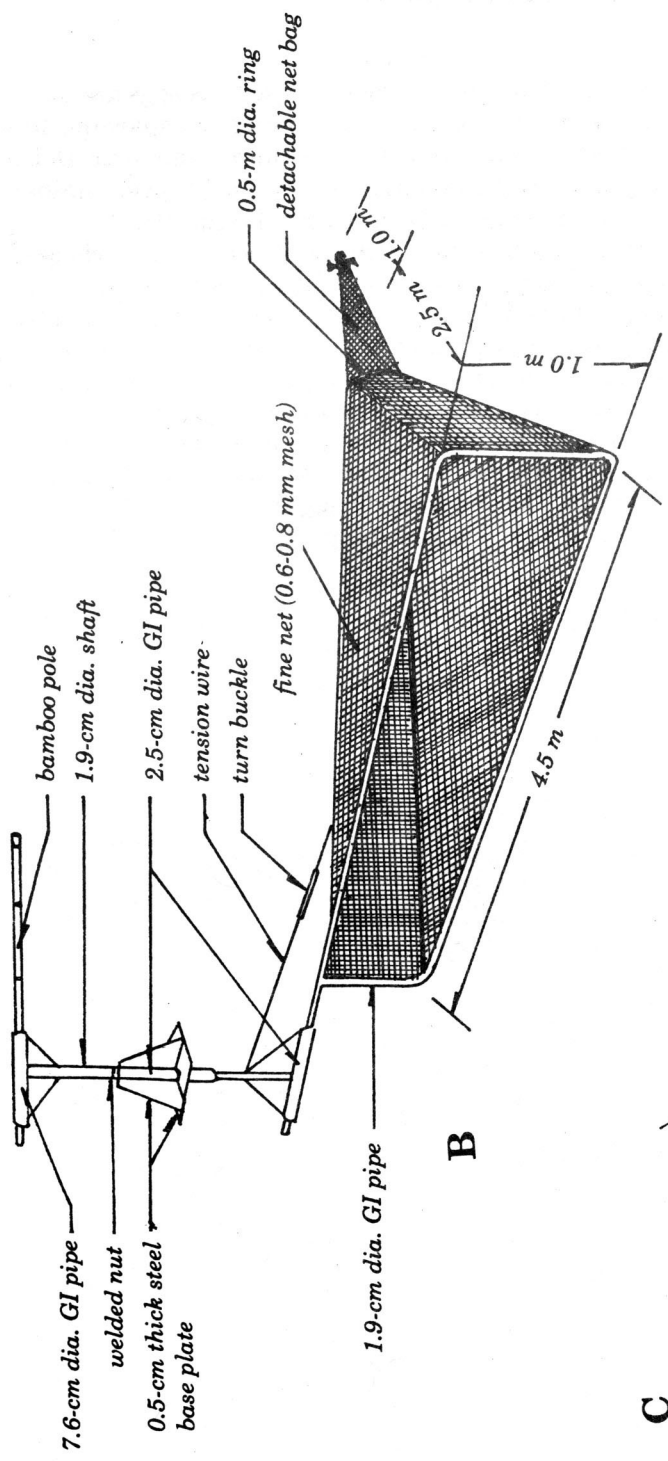

Fig. 14. A, Set-up of the wooden truss frame, egg collector, and hapa net in a 10-m dia. by 3-m deep floating net cage; B, details of the egg collector; C, details of the wooden truss frame with measurements in meters (Modified from Garcia *et al.*, 1988).



increase the water circulation in the cages. As soon as eggs are found during sampling of water from the cage, confirming that spawning has occurred, the egg collector is operated within 10 min. to an hour. Delay in collecting eggs can drastically decrease egg collection as egg cannibalism by milkfish spawners is known (Toledo and Gaitan, 1992).

In land-based broodstock tanks, the presence of eggs is checked daily around midnight by scooping water in a beaker. When present, the eggs are immediately collected. The egg collector consists of 2 airlift PVC pipes (4-in dia.) with outflows directed to a 1 m x 1 m x 1 m *hapa* net supported by a PVC pipe frame (Fig. 15). Two egg collectors are installed in each tank at the corners opposite the water inflow. Additional airlift pumps are installed with their outflows directed towards the egg collectors. The *hapa* nets are raised and rinsed, and the eggs scooped out. The nets are cleaned and sun dried during the day, then installed at night in anticipation of the next spawning.

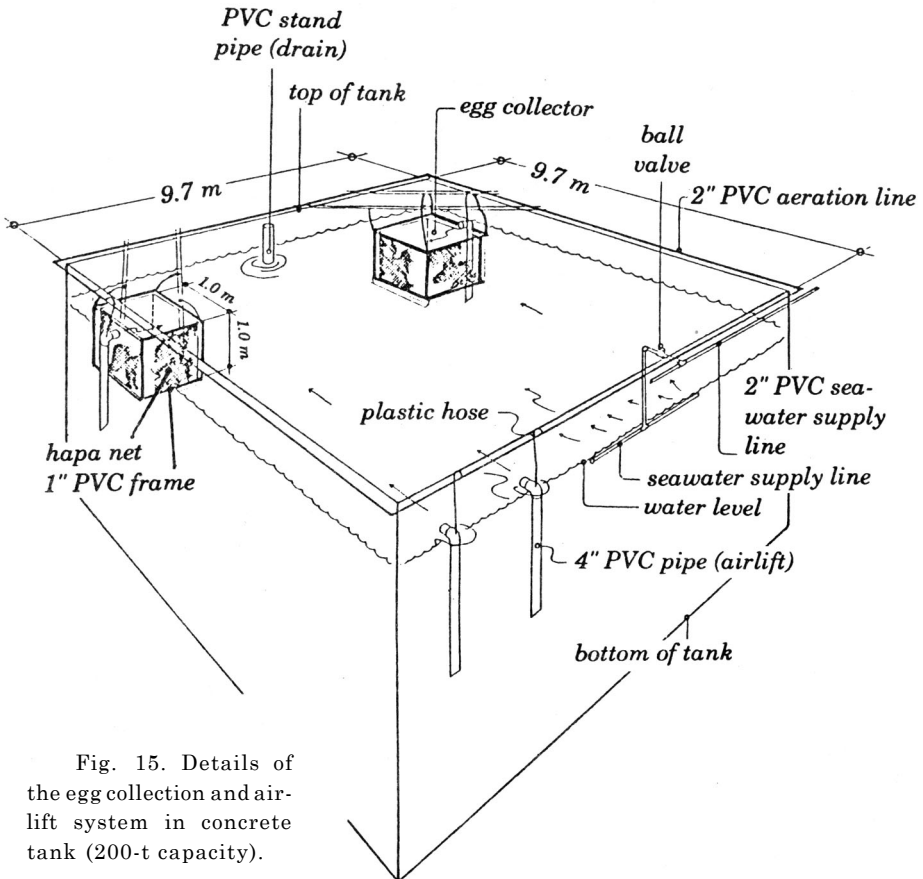

Fig. 15. Details of the egg collection and airlift system in concrete tank (200-t capacity).



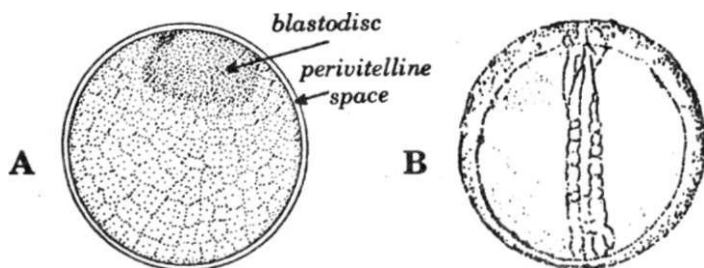

Fig. 16. Milkfish eggs: A, newly fertilized egg (1.1-1.25 mm dia.); and B, egg with developing embryo.

Fertilized milkfish eggs are spherical, finely granulated, pelagic, non-adhesive, transparent with a slight yellow tinge, and have no oil globule (Fig. 16). A developing embryo is visible 10 h after spawning. The time of spawning may be back-calculated from the stage of embryonic development at the time of egg collection (Bagarinao, 1991).

Following collection in cages, the conical bag is detached and placed in a pail containing 10 l of seawater. Milkfish eggs should not be allowed to stay out of seawater for more than a few minutes. The eggs are released from the net bag, taking care to dislodge eggs sticking to the net. The collected sample is then aerated to keep the eggs afloat, then transferred to a container with 400-1 filtered seawater.

### *Transport of eggs*

The hatchery must be located as close as possible to the broodstock cages or tanks to minimize mechanical damage of eggs due to handling and transport (Garcia and Toledo, 1988). The time spent for preparing eggs for transport and transport of eggs itself should be kept to a minimum. About an hour prior to transport, packing preparations should be underway following these steps:

Shut off the aeration. Swirl the water in the container at least once to concentrate dead eggs at the bottom. Siphon out dead eggs.

Set a double-lined plastic bag inside the *bayong* and fill with about 15 l filtered seawater (salinity, 28-32 ppt).

Scoop eggs with a fine mesh (0.6-0.8 mm) scoop net. With a beaker, take about 150-200 ml of eggs from the scoop net and quickly transfer to the *bayong*. About 60,000 eggs are contained in 100 ml.

Saturate each plastic bag with oxygen and seal tightly with rubber bands.

*Bayong* bags should be kept in the shade throughout transport. Water temperature in the bags should not go beyond 30°C during transport.

Upon reaching the hatchery, each plastic bag is placed in a hatching tank with 400-1 filtered and well-aerated seawater. After a 15-min acclimation, the plastic bag is opened and the eggs released. A stocking density of 250-300 eggs per liter should be maintained.

### ***Determination of percent egg viability***

Three subsamples using a PVC pipe (2-in dia.) are obtained from three sections of the hatching tank (Figs. 17-18). Eggs should be mildly aerated when subsampling is done. The three subsamples are pooled, then the number of live and dead eggs counted under a microscope. Viable eggs are transparent with a narrow perivitelline space and a blastodisc. Depending on the time of egg collection, an embryo may be visible. Dead eggs are opaque, and the unfertilized ones have no perivitelline space.

Calculations of total number of eggs and percent viability are as follows:

$$\text{Total no. of live/dead eggs} = \frac{\text{No. of live/dead eggs in sample}}{\text{Vol. of sample (l)}} \quad \text{Vol. of tank}$$

$$\text{Total no. of eggs} = \text{Total no. of live eggs} + \text{Total no. of dead or unfertilized eggs}$$

$$\text{Percent viability} = \frac{\text{Total no. of live eggs}}{\text{Total no. of eggs}} \times 100$$

For example

Vol. of incubation tank = 400 l

Vol. of sample = 2.5 l

No. of live eggs in sample = 5,000

No. of dead eggs in sample = 500



Fig. 17. Subsampling of incubation tanks to determine total number of eggs.

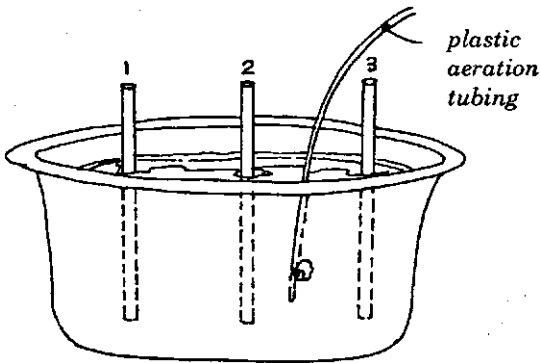

Fig. 18. Sections in the hatching tank from which to obtain subsamples for estimating total number of eggs and larvae.

$$\text{Total no. of live eggs} = \frac{5,000 \text{ eggs}}{2.5 \text{ l}} \times 400 \text{ l} = 800,000 \text{ eggs}$$

$$\text{Total no. of dead eggs} = \frac{500 \text{ eggs}}{2.5 \text{ l}} \times 400 \text{ l} = 80,000 \text{ eggs}$$

$$\text{Total no. of eggs} = 800,000 + 80,000 = 880,000$$

$$\text{Percent viability} = \frac{800,000}{880,000} \times 100\% = 90.91\%$$

### *Determination of hatching rate*

Milkfish eggs hatch between 20 and 24 h from spawning at temperatures of 26-32°C and salinities of 29-34 ppt (Chaudhuri *et al.*, 1978) (Fig. 19).

Upon hatching, at least three subsamples using a PVC pipe (2- in dia.) are obtained from each hatching tank. The three subsamples are pooled, and the numbers of normal larvae (straight body and without deformities) and abnormal larvae (curled body) are determined with a dissecting microscope. The hatching rate and percentage of normal larvae are then determined following these equations:

$$\text{Total no. of larvae} = \frac{\text{No. of normal and abnormal larvae in sample}}{\text{Vol. of sample}} \times \text{Vol. of hatching tank}$$

$$\text{Hatching rate} = \frac{\text{Total no. of larvae}}{\text{Total no. of live eggs}} \times 100$$

$$\text{Percent normal larvae} = \frac{\text{Total no. of normal larvae}}{\text{Total no. of larvae}} \times 100$$

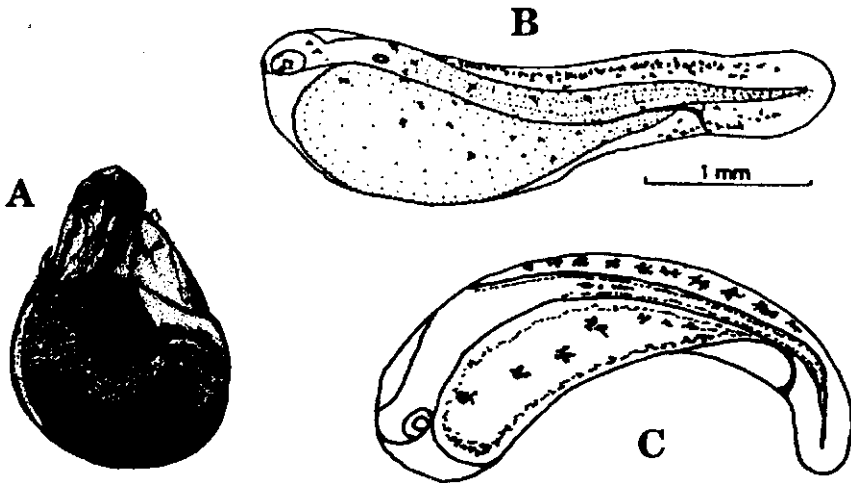

Fig. 19. A, Hatching of milkfish larva; B, newly hatched normal larva; and C, abnormal larva.

For example

Vol. of incubation tank = 400 l

Vol. of sample = 2.5 l

No. of normal larvae in sample = 4,000

No. of abnormal larvae in sample = 200

$$\text{Total no. of larvae} = \frac{4,000 + 200 \text{ larvae}}{2.5 \text{ l}} \times 400 \text{ l} = 672,000 \text{ larvae}$$

$$\text{Hatching rate} = \frac{672,000}{800,000} \times 100\% = 84\%$$

$$\text{Total no. of normal larvae} = \frac{4,000 \text{ larvae}}{2.5 \text{ l}} \times 400 \text{ l} = 640,000$$

$$\text{Percent normal larvae} = \frac{640,000}{672,000} \times 100\% = 95.24\%$$

## *Postscript*

Research on broodstock nutrition is very important for further refining the management techniques described in this manual. The production of good quality eggs and larvae depends on proper broodstock nutrition. Another area for research is the method of obtaining gonadal maturation and spawning in milkfish outside its breeding season. Success in these two areas - broodstock nutrition and off-season maturation and spawning - will augment the seed supply of milkfish perhaps to the point where dependence on natural supply will be minimized, if not, eliminated.

## *Acknowledgment*

The authors are extremely grateful to all the staff of the Breeding Section based at the Tigbauan Main Station and Igang Marine Substation and to I.G. Borlongan for formulating the broodstock diet. Their valuable contributions have made possible the development of the milkfish broodstock management technique described in this manual.

The authors also thank G.F. Qunitio, T.U. Bagarinao, R.M. Coloso, J.D. Tan-Fermin, and M.T. Castaños for reviewing the manual; the Engineering Section for supplying some of the schematic diagrams; the Audiovisual-Print Section for producing the manual; and, SEAFDEC/AQD Chief E.E.C. Flores for supporting the publication.

## References

- Bagarinao, TU. 1991. Biology of Milkfish (*Chanos chanos* Forsskal). Iloilo, Philippines: SEAFDEC Aquaculture Department. 94 pp.
- Chaudhuri H, Juario J, Samson R, and Tiro R. 1977. Notes on the external sex characters of *Chanos chanos* (Forsk.) spawners. Fish. Res. J. Philipp. 1: 76-80.
- Chaudhuri H, Juario JV, Primavera JH, Samson R, and Mateo R. 1978. Observations on artificial fertilization of eggs and the embryonic and larval development of milkfish *Chanos chanos* (Forsskal). Aquaculture 13:95-113.
- Emata AC and Marte CL. 1990. Natural and induced spawning of milkfish, *Chanos chanos* (Forsskal), in concrete tanks. SEAFDEC Asian Aquaculture 12:1-3.
- Emata AC and Marte CL. 1991. Reproductive performance of milkfish in concrete tanks. SEAFDEC Asian Aquaculture 13:5-6.
- Fishery Statistics Bulletin. 1991. Department of Agriculture, Bureau of Fisheries and Aquatic Resources. Quezon City, Metro Manila.
- Gapasin, RSJ and Marte CL. 1990. Milkfish hatchery operations. Aquaculture Extension Manual No. 17, SEAFDEC Aquaculture Dept. Iloilo. 24 pp.
- Garcia LMaB and Toledo JD. 1988. Critical factors influencing survival and hatching of milkfish (*Chanos chanos* Forsskal) eggs during simulated transport. Aquaculture 72:85-93.
- Garcia LMaB, Marte CL, and Travina VS. 1988. A collecting gear for naturally spawned milkfish (*Chanos chanos* Forsskal) eggs in circular floating net cages. Aquaculture 68:83-86.
- Juario JV, Duray MN, Duray VM, Nacario JF, and Almendras JME. 1984. Induced breeding and larval rearing experiments with milkfish, *Chanos chanos* Forsskal, in the Philippines. Aquaculture 36: 61-70.
- Lacanilao FJ and Marte CL. 1980. Sexual maturation of milkfish in floating cages. Asian Aquaculture 3:4-6.
- Marte CL. 1988. An improved method for collecting naturally spawned milkfish eggs from floating cages. Aquaculture 71:387-392.
- Marte CL. 1989. Studies on the reproductive physiology of milkfish (*Chanos chanos* Forsskal). Ph.D. dissertation, National University of Singapore. 271 p.
- Marte CL and Lacanilao FJ. 1986. Spontaneous maturation and spawning of milkfish in floating net cages. Aquaculture 53:115-132.
- Marte CL, Qunitio GF, Garcia LMB, and Lacanilao FJ. 1984. A guide to the establishment and maintenance of milkfish broodstock. SEAFDEC Aquaculture Department Technical Report No. 11. 36 p.
- Marte CL, Sherwood NM, Crim LW and Tan JD. 1988. Induced spawning of maturing milkfish (*Chanos chanos*) using human chorionic gonadotropin and mammalian and salmon gonadotropin-releasing hormone analogues. Aquaculture 74:333-340.
- Toledo JD and Gaitan AG. 1992. Egg cannibalism by milkfish (*Chanos chanos* Forsskal) spawners in circular floating cages. J. Appl. Ichthyol. 83:257-262.



**MANAGEMENT OF MILKFISH BROODSTOCK**  
AQUACULTURE EXTENSION MANUAL NO. 20  
DECEMBER 1992

